

Носачи на кабли и спојни елементи





AKTIVA ИНЖЕНЕРИНГ е водечки градежен бренд, најуспешна компанија и најголем изведувач во делот на изведбата на комерцијални и деловни објекти. Компанијата е позиционирана во срцето на индустрискиот регион во Штип и како приватна компанија, прва започна да функционира во овој дел од металската индустрија. Компанијата функционира успешно две децении и претставува синоним за стабилна и квалитетна изведба за што сведочат бројните задоволни инвеститори. Поседуваме висококлучен, искусен, докажан, едуциран и професионален тим. Во текот на своето функционирање АКТИВА ИНЖЕНЕРИНГ успешно менаџира и работи на огромен број проекти и притоа се стекна со сеопфатно знаење и искуство за градежната индустрија, вложувајќи ги потоа во секој сегмент во бизнисот. Нашите искуства не инспирираа да ги подигнеме стандардите на индустријата, докажувајќи дека до квалитетот може да се стигне единствено со фер цена. Ние претставуваме градежна компанија која обезбедува супериорни, квалитетни градежни услуги и оперативна совршеност преку ефикасно планирање, директна комуникација и конкурентни цени. Нашиот тим е исклучително искусен во проценувањето, управувањето, изводливоста и финансирањето на различни видови проекти. Подобрувањето на ова сеопфатно искуство и знаење гарантира дека клиентите добиваат квалитетна работа, фер цени и посветено внимание на нивниот проект. Со текот на годините АКТИВА ИНЖЕНЕРИНГ има изградено односи со врвни добавувачи и подизведувачи во индустријата и сите се придржуваат кон нашите високи стандарди за квалитет. Ние користиме високо развиен систем на планирање и соработка со клиентите пред почетокот на секој проект за да ги отвориме линиите за комуникација и да воспоставиме јасни насоки (т.е. буџет, распоред, начин на изведба итн.). Согласно европското законодавство, АКТИВА ИНЖЕНЕРИНГ е меѓународно сертифицирана компанија од градежниот сектор. Специјализирани сме и лиценцирани за изведба на градби од прва категорија, со лиценца А издадена од министерството за транспорт и врски на Република Македонија и комплетна ISO стандардизација. Во своето работење компанијата ги применува современите европски стандарди и иновации за сигурно, квалитетно и економично градење.

Дејноста на АКТИВА ИНЖЕНЕРИНГ во градежната и металската индустрија опфаќа се на едно место: проектирање, изведба, надзор и ревизија на градби од прва категорија. Потоа секаков вид преработка на метали, комплет инженеринг услуги, консалтинг, инвестирање, трговија. Специјалност при изведба на комерцијални и деловни објекти:

- производство и монтажа на секаков вид челични конструкции;
- покривачки, фасадерски и лимарски работи со панелни системи или профилирани и пластифицирани лимови;
- инсталации за греење, ладење и климатизација (HVAC);
- електрични инсталации и автоматизација;
- производство и монтажа на метални носачи на кабли и додатни спојни елементи;
- инсталации за водовод и канализација;
- изведба на хоризонтални и вертикални резервоари за потребни намени;
- производство на процесна технолошка опрема за винарската индустрија, рафинерии за масло, складови и манипулација со горива ;
- комплет инженеринг услуги и сл.



AKTIVA ENGINEERING is a leading brand, the most successful company and the biggest performer in the part of the commercial and industrial buildings. The company is positioned in the heart of the industrial region of Stip and as a private company, it first started to function in this part of the metal industry. The company has been operating successfully for two decades and is a synonym for a stable and high quality building implementation, as well as numerous satisfied investors. We have a high-quality, experienced, proven, educated and professional team. In the course of its functioning, AKTIVA ENGINEERING successfully manages and works on a large number of projects and has acquired a comprehensive knowledge and experience for the construction industry, bringing them in every segment of the business. Our experience inspire us to raise industry standards, proving that quality can only be achieved with a fair price. We represent a construction company that provides superior, quality construction services and operational solvency through efficient planning, direct communication and competitive pricing. Our team is exceptionally experienced in the assessment, management, feasibility and financing of various types of projects. Improving this comprehensive experience and significance guarantees that customers receive quality work, fair prices and a dedicated engagement of their project. Throughout the years, AKTIVA ENGINEERING has built relationships with rower and sub-contractors in the industry and they are all adhered to our high quality standards. We use a highly developed system of planning and collaborating with clients before the beginning of each project to open the lines of communication and to establish clear guidelines (ie budget, schedule, implementation method, etc.). According to the European legislation, AKTIVA ENGINEERING is an internationally certified company of the construction sector. Specialized and licensed for construction performance of the first category, with license A issued by the Ministry of Transport and Communications of the Republic of Macedonia and complete ISO standardization. In its operations, the company applies the modern European standards and innovations for safe, quality and economical construction.

The activities of AKTIVA ENGINEERING in the construction and metal industry are covered in one place: design, construction, supervision and revision of the construction of the first category buildings. Then there is all kind of metal processing, complete engineering services, consulting, investing, trading. Our specialization in commercial and industrial buildings:

- production and installation of any type of steel construction;
- roofing, facade and tin work with panel systems or profiled and plastic sheets;
- heating, cooling and air conditioning installations;
- electrical installations and automation;
- production and installation of metal cables on the cables and additional coupling elements;
- plumbing and sewerage installations;
- construction on horizontal and vertical tanks for the necessary purposes;
- production of process technological equipment for the wine industry, oil refiners, fuels and manipulation with fuels;
- complet engineering services.



ПЕРФОРИРАН МЕТАЛЕН НОСАЧ НА КАБЛИ



PERFORATED CABLE TRAYS

	Ознака Order code	Ширина / Width A (mm)	Должина / Length L (mm)	Висина / Height H (mm)	Дебелина / Thickness δ (mm)
1	PNK - 50	50	2000	40	$\delta = 0.6$
2	PNK - 100	100	2000	40	$\delta = 0.6$
3	PNK - 150	150	2000	40	$\delta = 0.6$
4	PNK - 200	200	2000	40	$\delta = 0.7$
5	PNK - 300	300	2000	40	$\delta = 0.9$
6	PNK - 400	400	2000	40	$\delta = 1.0$

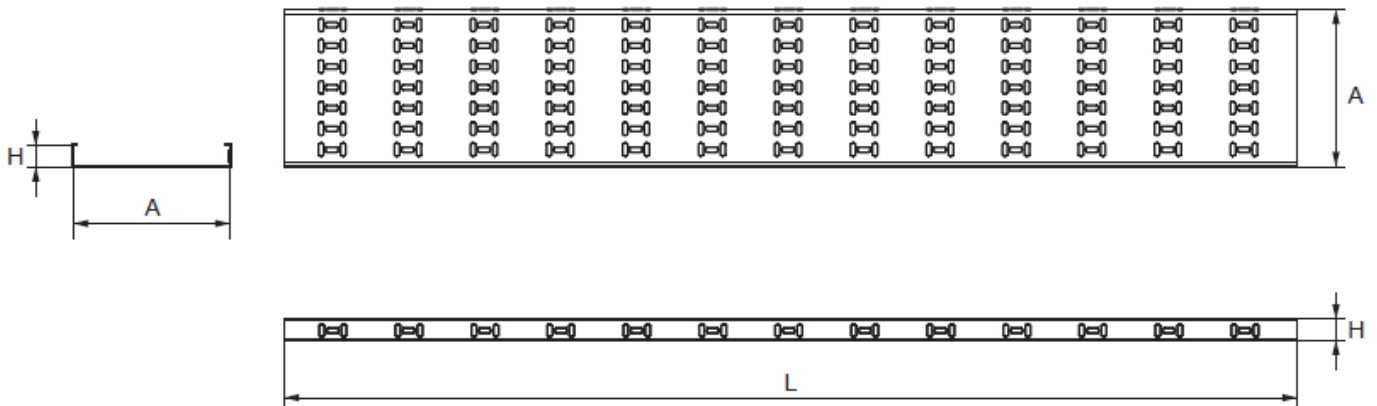
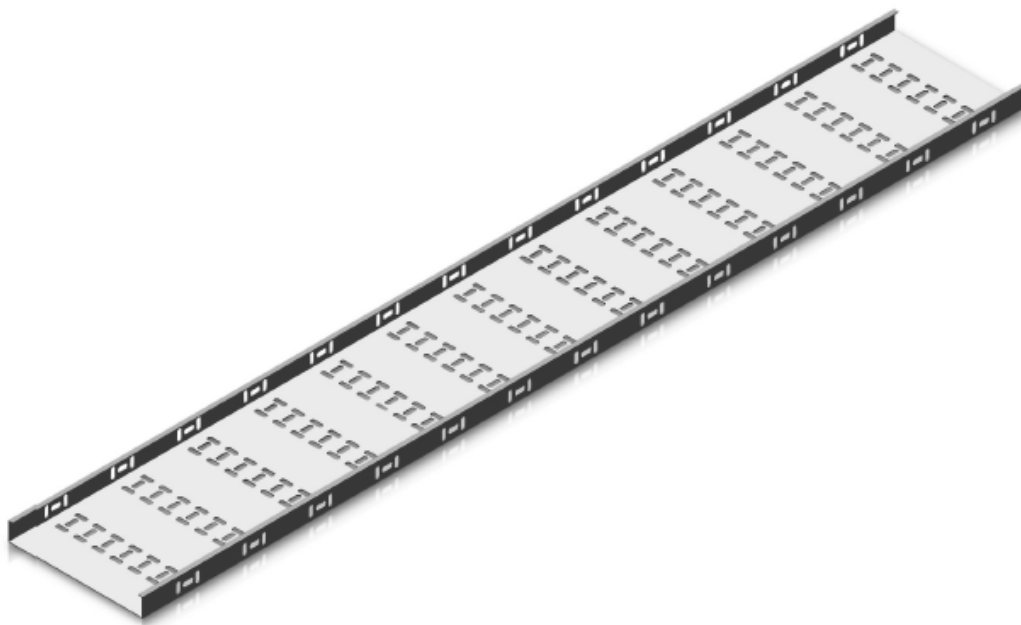



РАМНА СПОЈКА



FLAT CLUTCH

	Ознака Order code	Ширина / Width A (mm)	Должина / Length L (mm)	Висина / Height H (mm)	Дебелина / Thickness δ (mm)
7	RS - 100	100	160	40	$\delta = 0.6$
8	RS - 150	150	160	40	$\delta = 0.6$
9	RS - 200	200	160	40	$\delta = 0.6$
10	RS - 300	300	160	40	$\delta = 0.7$
11	RS - 400	400	160	40	$\delta = 0.9$
12	RS - 500	500	160	40	$\delta = 1.0$

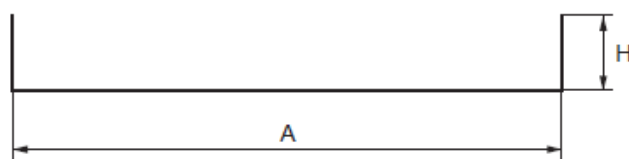
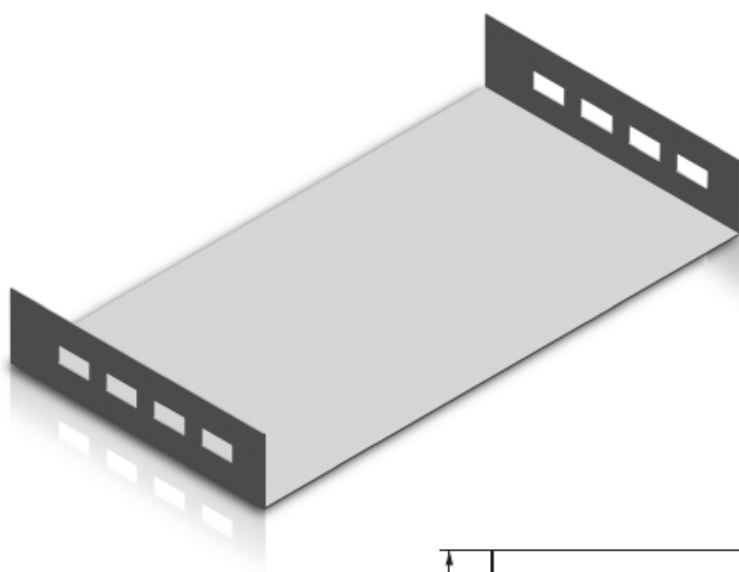



АГОЛНА СПОЈКА



ANGLE CLUTCH

	Ознака Order code	Ширина / Width A (mm)	Ширина/ Width B (mm)	Висина / Height H (mm)	Дебелина / Thickness δ (mm)
13	LS - 100/90°	100	100	40	$\delta = 0.6$
14	LS - 150/90°	150	150	40	$\delta = 0.6$
15	LS - 200/90°	200	200	40	$\delta = 0.7$
16	LS - 300/90°	300	300	40	$\delta = 0.9$
17	LS - 400/90°	400	400	40	$\delta = 1.0$

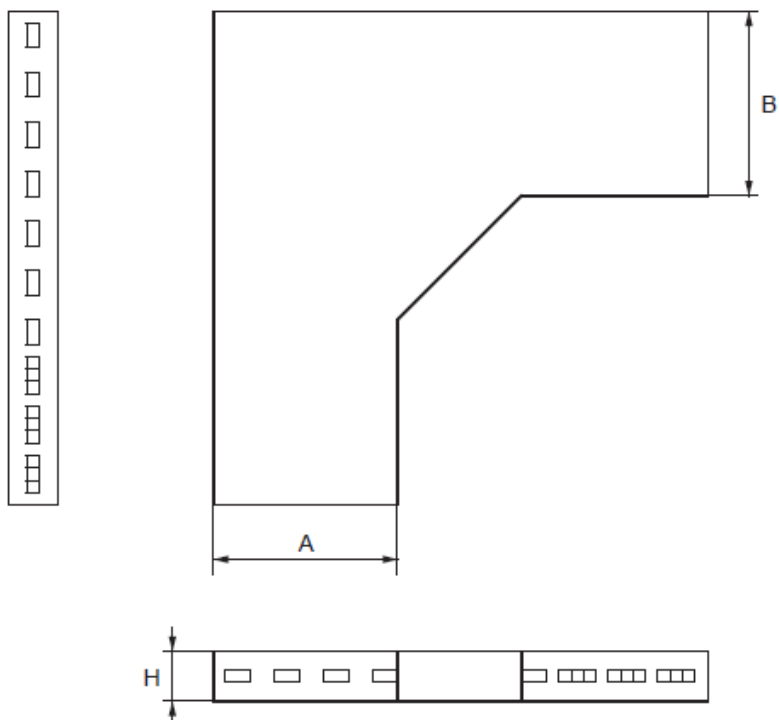
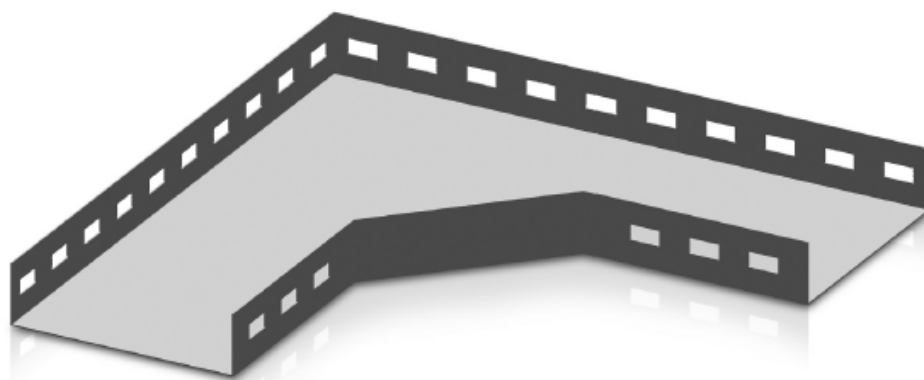



ВЕРТИКАЛНА НАДВОРЕШНА СПОЈКА



VERTICAL EXTERNAL CLUTCH

	Ознака Order code	Ширина / Width A (mm)	Висина / Height H (mm)	Дебелина / Thickness δ (mm)
18	VNS - 100/90°	100	40	$\delta = 0.6$
19	VNS - 150/90°	150	40	$\delta = 0.6$
20	VNS - 200/90°	200	40	$\delta = 0.7$
21	VNS - 300/90°	300	40	$\delta = 0.7$

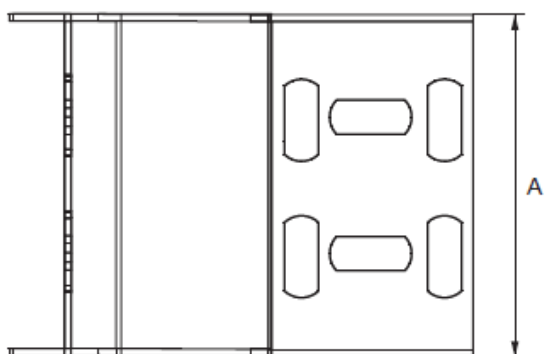
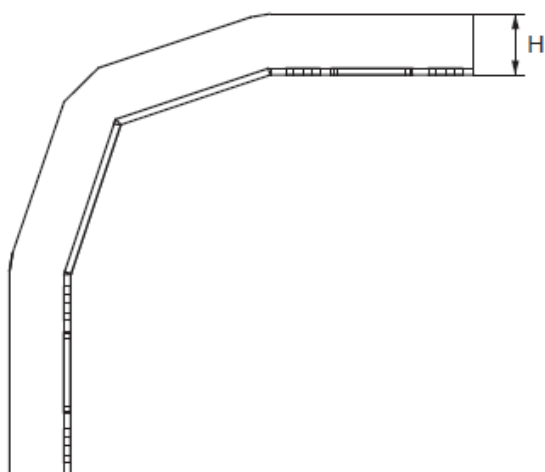

ВЕРТИКАЛНА ВНАТРЕШНА СПОЈКА

VERTICAL INTERNAL CLUTCH

	Ознака Order code	Ширина / Width A (mm)	Висина / Height H (mm)	Дебелина / Thickness δ (mm)
22	VVS - 100/90°	100	40	$\delta = 0.6$
23	VVS - 150/90°	150	40	$\delta = 0.6$
24	VVS - 200/90°	200	40	$\delta = 0.7$
25	VVS - 300/90°	300	40	$\delta = 0.7$

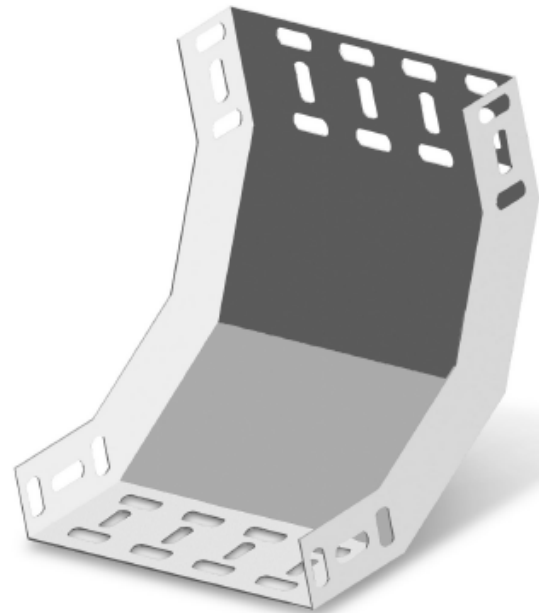
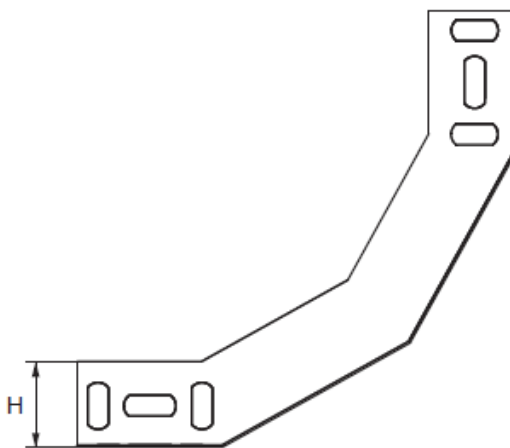
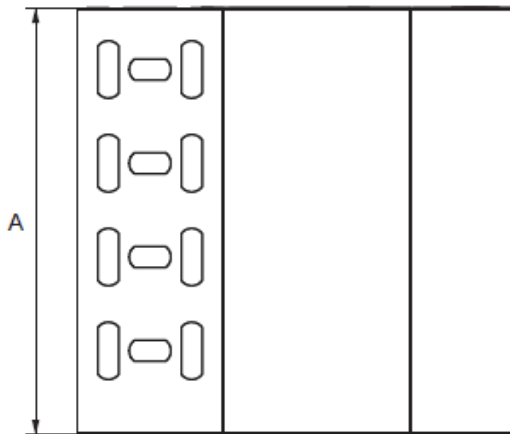



T - СПОЈКА



T - CLUTCH

	Ознака Order code	Ширина / Width A (mm)	Ширина/ Width B (mm)	Висина / Height H (mm)	Дебелина / Thickness δ (mm)
26	TS - 100/50	100	50	40	$\delta = 0.7$
27	TS - 100/100	100	100	40	$\delta = 0.7$
28	TS - 150/100	150	100	40	$\delta = 0.6$
29	TS - 150/150	150	150	40	$\delta = 0.7$
30	TS - 200/100	200	100	40	$\delta = 0.7$
31	TS - 200/200	200	200	40	$\delta = 0.8$
32	TS - 300/200	300	200	40	$\delta = 0.8$
33	TS - 300/300	300	300	40	$\delta = 0.7$
34	TS - 400/200	400	200	40	$\delta = 0.7$
35	TS - 400/300	400	300	40	$\delta = 0.7$
36	TS - 400/400	400	400	40	$\delta = 0.9$

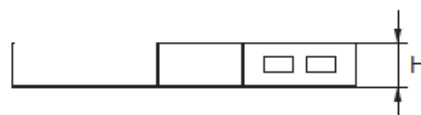
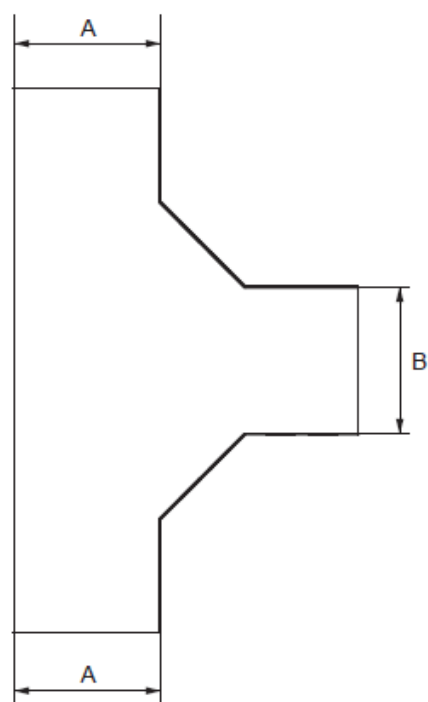
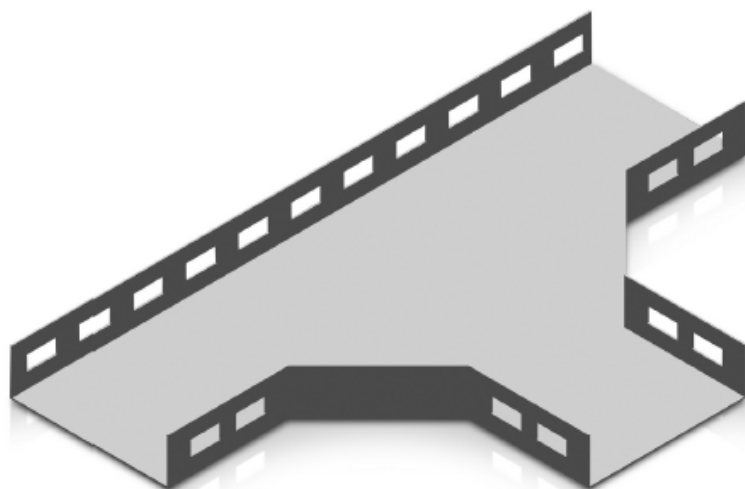

**X - СПОЈКА****X - CLUTCH**

	Ознака Order code	Ширина / Width A (mm)	Ширина/Width B (mm)	Висина / Height H (mm)	Дебелина / Thickness δ (mm)
37	XS - 100/100	100	100	40	$\delta = 0.6$
38	XS - 150/150	150	150	40	$\delta = 0.7$
39	XS - 200/200	200	200	40	$\delta = 0.8$
40	XS - 300/300	300	300	40	$\delta = 0.8$

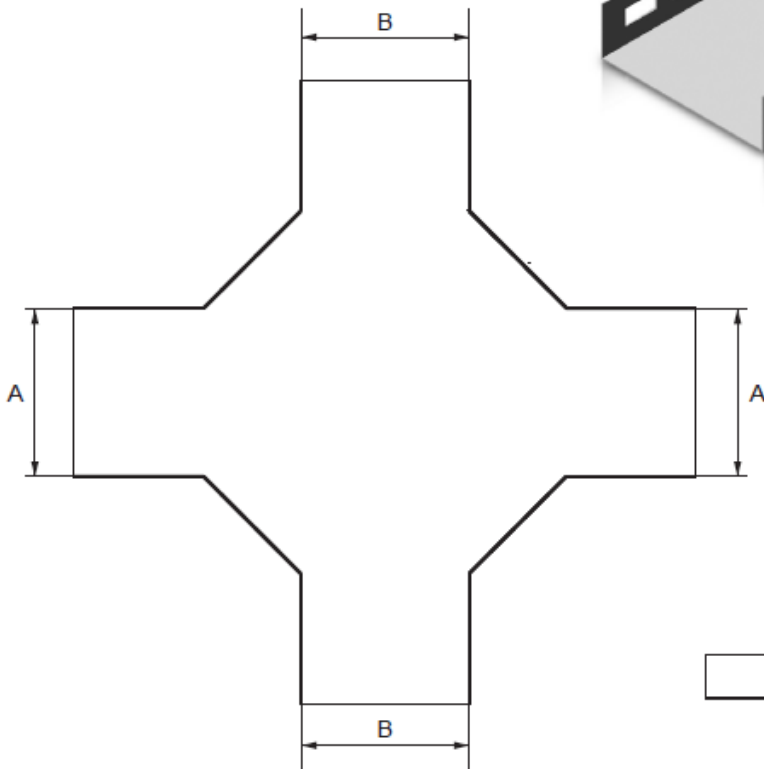
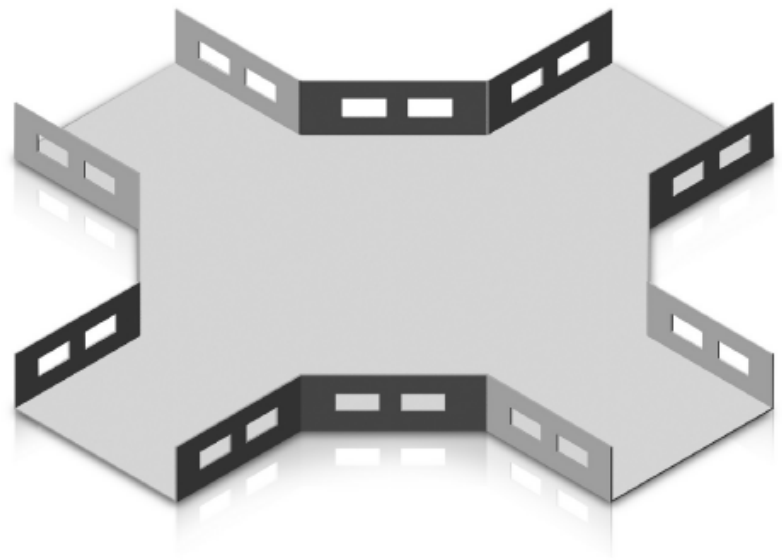



РЕДУЦИР



REDUCER

	Ознака Order code	Ширина / Width A (mm)	Ширина / Width B (mm)	Должина / Length L (mm)	Висина / Height H (mm)	Дебелина / Thickness δ (mm)
41	PR - 100/50	100	50	220	40	$\delta = 0.6$
42	PR - 150/100	150	100	220	40	$\delta = 0.6$
43	PR - 200/100	200	100	220	40	$\delta = 0.7$
44	PR - 300/200	300	200	220	40	$\delta = 0.7$

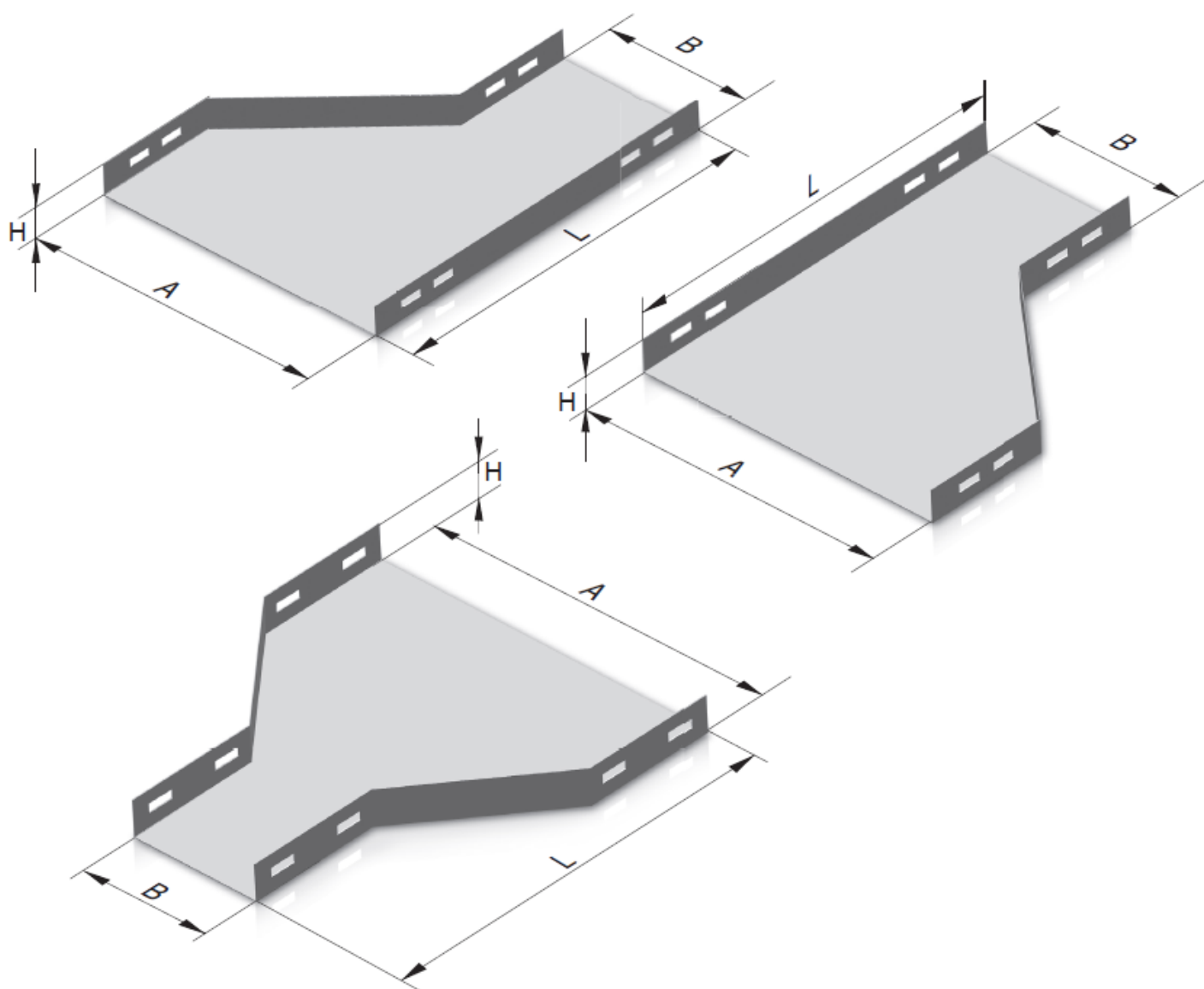



КАПАК ЗА ПЕРФОРИРАН НОСАЧ НА КАБЛИ



COVER FOR PERFORATED CABLE TRAYS

	Ознака Order code	Ширина / Width A (mm)	Должина / Length L (mm)	Висина / Height H (mm)	Дебелина / Thickness δ (mm)
45	KNK - 50	50	2000	10	$\delta = 0.6$
46	KNK - 100	100	2000	10	$\delta = 0.6$
47	KNK - 150	150	2000	10	$\delta = 0.6$
48	KNK - 200	200	2000	10	$\delta = 0.6$
49	KNK - 300	300	2000	10	$\delta = 0.7$
50	KNK - 400	400	2000	10	$\delta = 0.7$

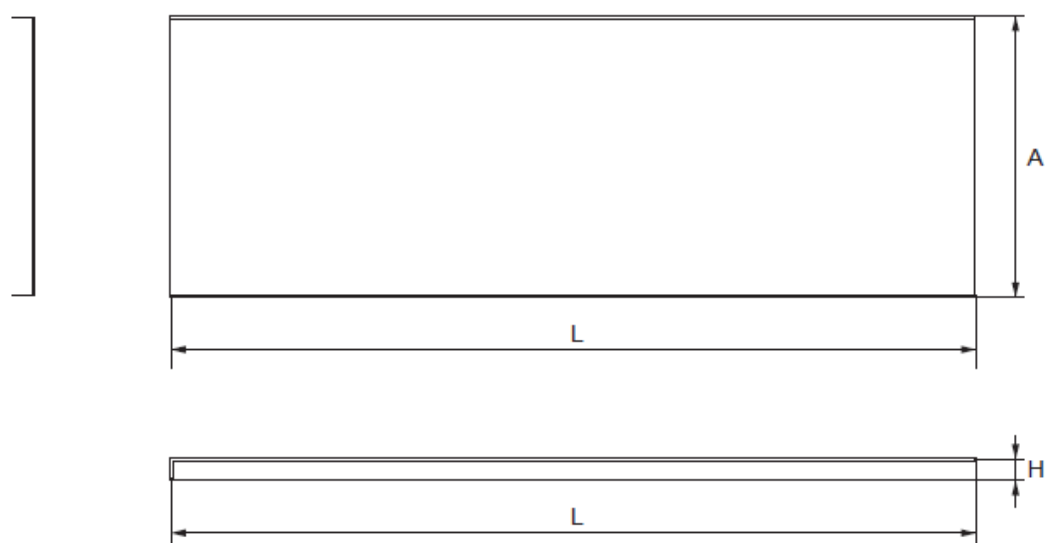
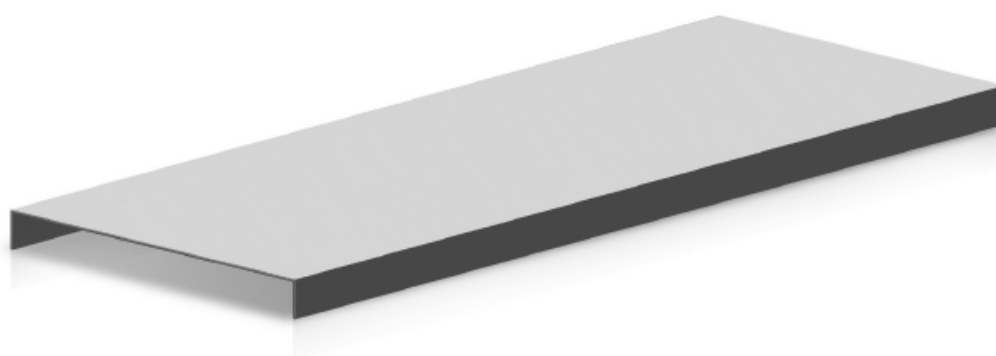



КАПАК ЗА ВНАТРЕШНА СПОЈКА



COVER FOR INTERNAL CLUTCH

	Ознака Order code	Ширина / Width A (mm)	Ширина/ Width B (mm)	Висина / Height H (mm)	Дебелина / Thickness δ (mm)
51	KVS - 100	100	180	10	$\delta = 0.6$
52	KVS - 150	150	180	10	$\delta = 0.6$
53	KVS - 200	200	190	10	$\delta = 0.6$
54	KVS - 300	300	200	10	$\delta = 0.6$
55	KVS - 400	400		10	$\delta = 0.7$



КАПАК ЗА НАДВОРЕШНА СПОЈКА



COVER FOR EXTERNAL CLUTCH

	Ознака Order code	Ширина / Width A (mm)	Ширина/ Width B (mm)	Висина / Height H (mm)	Дебелина / Thickness δ (mm)
56	KVNS - 100	100	180	10	$\delta = 0.6$
57	KVNS - 150	150	180	10	$\delta = 0.6$
58	KVNS - 200	200	190	10	$\delta = 0.6$
59	KVNS - 300	300	200	10	$\delta = 0.6$
60	KVNS - 400	400			$\delta = 0.7$



КАПАК ЗА АГОЛНА СПОЈКА



COVER FOR ANGLE CLUTCH

	Ознака Order code	Ширина / Width A (mm)	Висина / Height H (mm)	Дебелина / Thickness δ (mm)
61	KLS - 100	100	10	$\delta = 0.6$
62	KLS - 150	150	10	$\delta = 0.6$
63	KLS - 200	200	10	$\delta = 0.6$
64	KLS - 300	300	10	$\delta = 0.6$
65	KLS - 400	400	10	$\delta = 0.7$

КОНЗОЛА

BRACKET

	Ознака Order code	Ширина/Width B (mm)	Ширина /Width A (mm)	Висина / Height H (mm)	Дебелина / Thickness δ (mm)
66	KZ - 100	100	40	120	$\delta = 2.0$
67	KZ - 150	150	40	120	$\delta = 2.0$
68	KZ - 200	200	40	120	$\delta = 2.0$
69	KZ - 300	300	40	120	$\delta = 2.0$
70	KZ - 400	400	40	125	$\delta = 2.0$
71	KZ - 500	500	40	140	$\delta = 3.0$
72	KZ - 600	600	40	140	$\delta = 3.0$

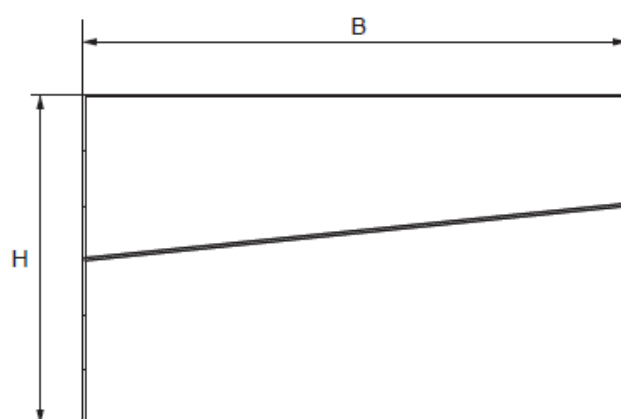
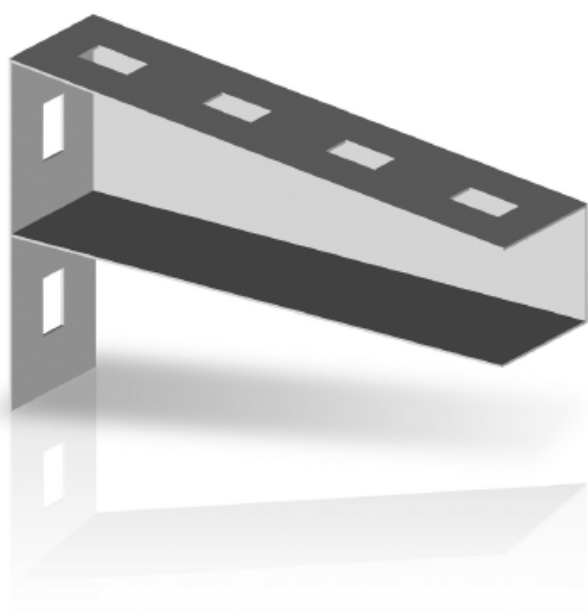
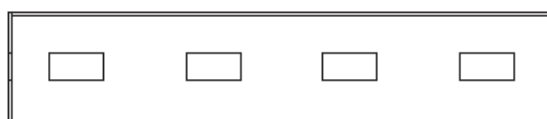



ТАВАНСКИ НОСАЧ



ROOF TRAY

	Ознака Order code	Должина / Length L (mm)	Ширина / Width A (mm)	Висина / Height H (mm)	Дебелина / Thickness δ (mm)
73	TNS - 200	200	60	45	$\delta = 2.0$
74	TNS - 300	300	60	45	$\delta = 2.0$
75	TNS - 400	400	60	45	$\delta = 2.0$
76	TNS - 500	500	60	45	$\delta = 2.0$
77	TNS - 600	600	60	45	$\delta = 2.0$
78	TNS - 800	800	60	45	$\delta = 3.0$
79	TNS - 1000	1000	60	45	$\delta = 3.0$

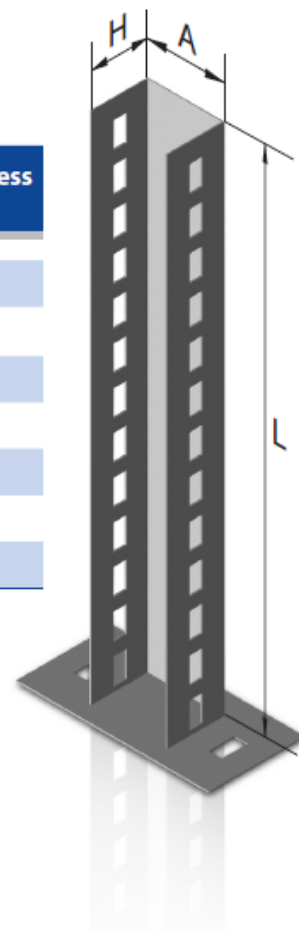

ВЕРТИКАЛЕН НОСАЧ



VERTICAL TRAY

	Ознака Order code	Должина / Length L (mm)	Ширина / Width A (mm)	Висина / Height H (mm)	Дебелина / Thickness δ (mm)
80	VS - 250	250	60	45	$\delta = 2.0$
81	VS - 300	300	60	45	$\delta = 2.0$
82	VS - 400	400	60	45	$\delta = 2.0$
83	VS - 500	500	60	45	$\delta = 2.0$
84	VS - 600	600	60	45	$\delta = 3.0$
85	VS - 1000	1000	60	45	$\delta = 3.0$

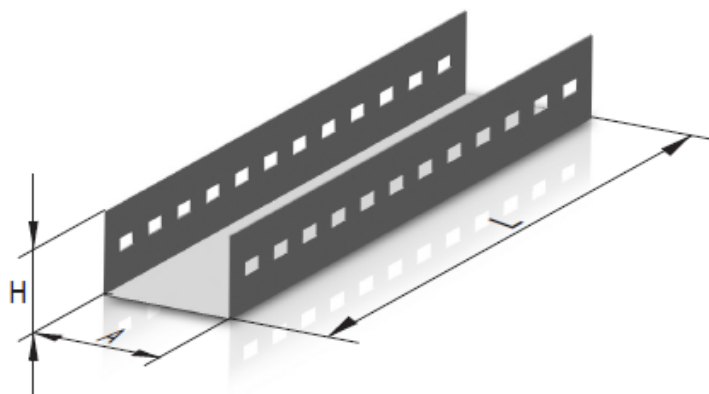



УНИВЕРЗАЛЕН НОСАЧ НА РНК И СВЕТИЛКИ



UNIVERSAL GIRDER FOR PNK AND LAMPS

	Ознака Order code	Должина / Length L (mm)	Ширина / Width A (mm)	Висина / Height H (mm)	Дебелина / Thickness δ (mm)
86	URNK	1000	40	20	$\delta = 2.0$

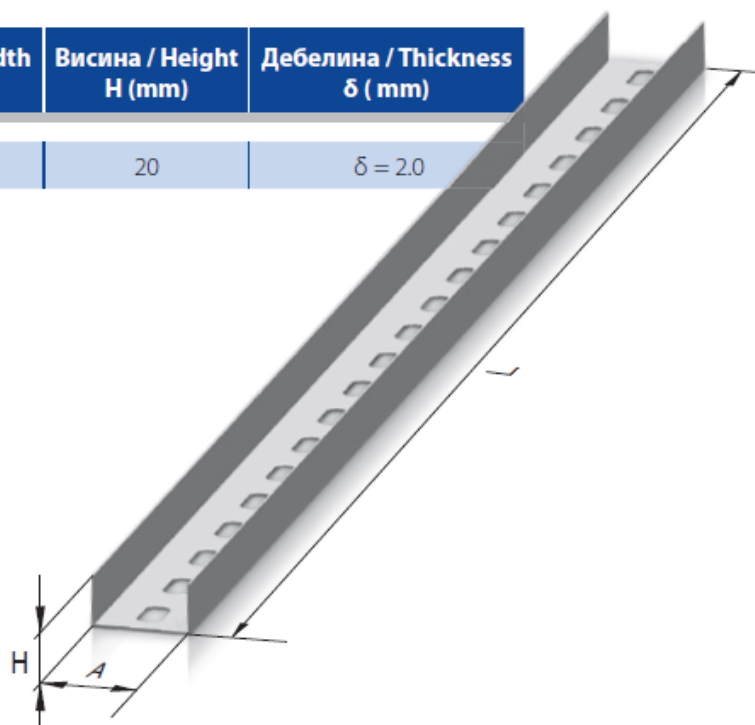

УНИВЕРЗАЛНА СПОЈКА



UNIVERSAL CLUTCH

	Ознака Order code	Ширина / Width B (mm)	Ширина / Width A (mm)	Висина / Height H (mm)	Дебелина / Thickness δ (mm)
87	US	200	30	50	$\delta = 2.0$

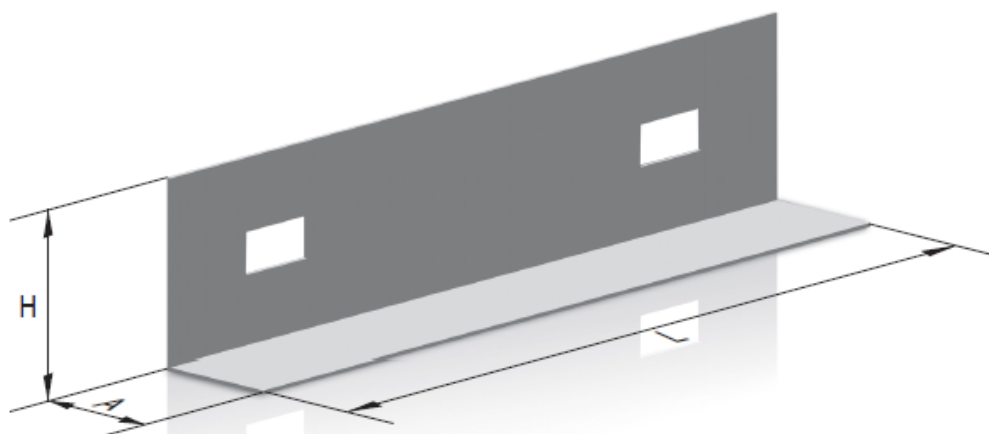



РЕШЕТКАСТ НОСАЧ НА КАБЕЛ



LATTICE CABLE TRAYS

	Ознака Order code	Ширина / Width A (mm)	Должина / Length L (mm)	Висина / Height H (mm)	Дебелина / Thickness δ (mm)
88	RNK - 200	200	2000	50	$\delta = 2.0$
89	RNK - 300	300	2000	50	$\delta = 2.0$
90	RNK - 400	400	2000	50	$\delta = 2.0$
91	RNK - 500	500	2000	50	$\delta = 2.0$
92	RNK - 600	600	2000	50	$\delta = 2.0$

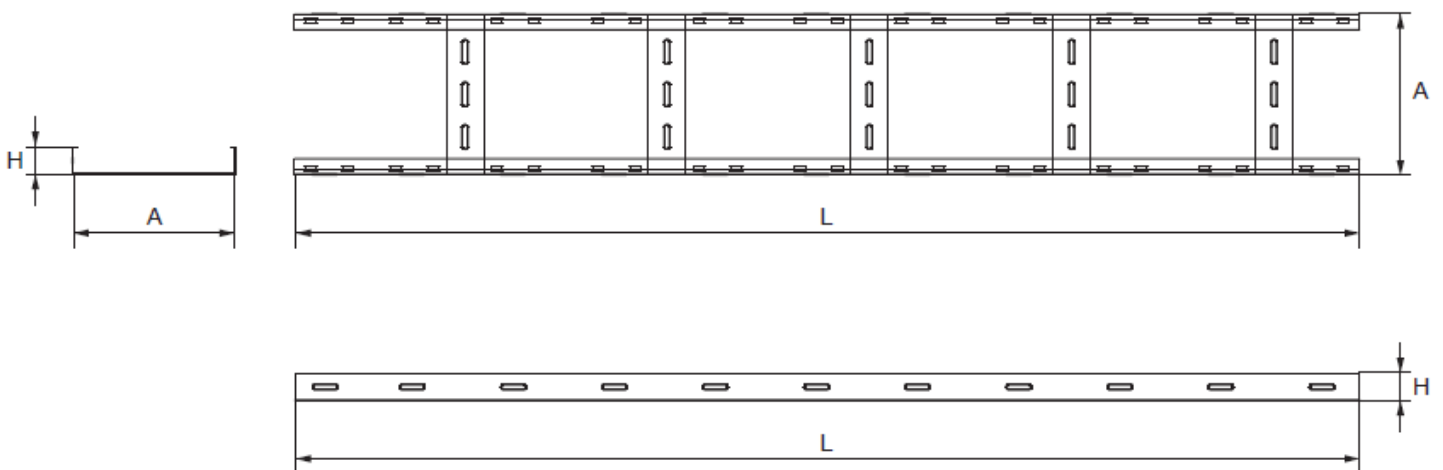
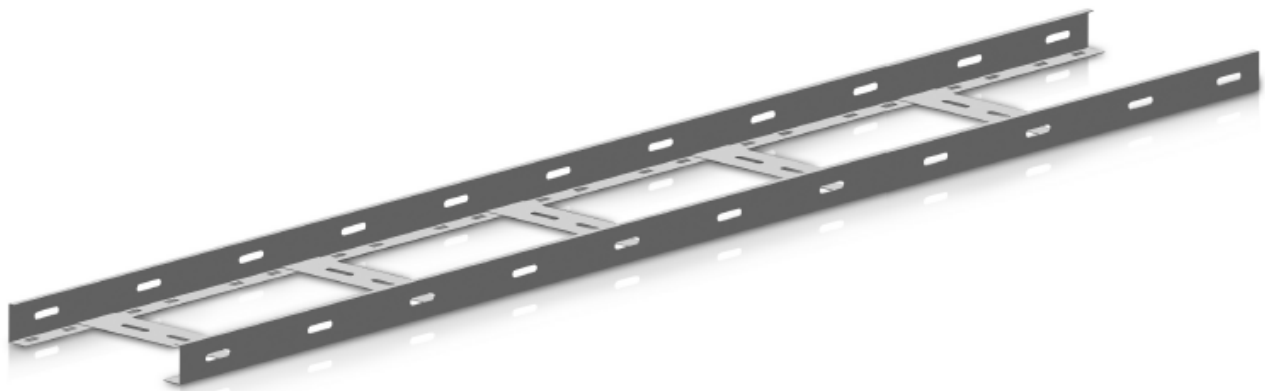

АГОЛНА РЕШЕТКАСТА СПОЈКА

ANGLE LATTICE CLUTCH

	Ознака Order code	Ширина / Width A (mm)	Висина / Height H (mm)	Дебелина / Thickness δ (mm)
93	RLS - 200/90	200	50	$\delta = 2.0$
94	RLS - 300/90	300	50	$\delta = 2.0$
95	RLS - 400/90	400	50	$\delta = 2.0$
96	RLS - 500/90	500	50	$\delta = 2.0$
97	RLS - 600/90	600	50	$\delta = 2.0$

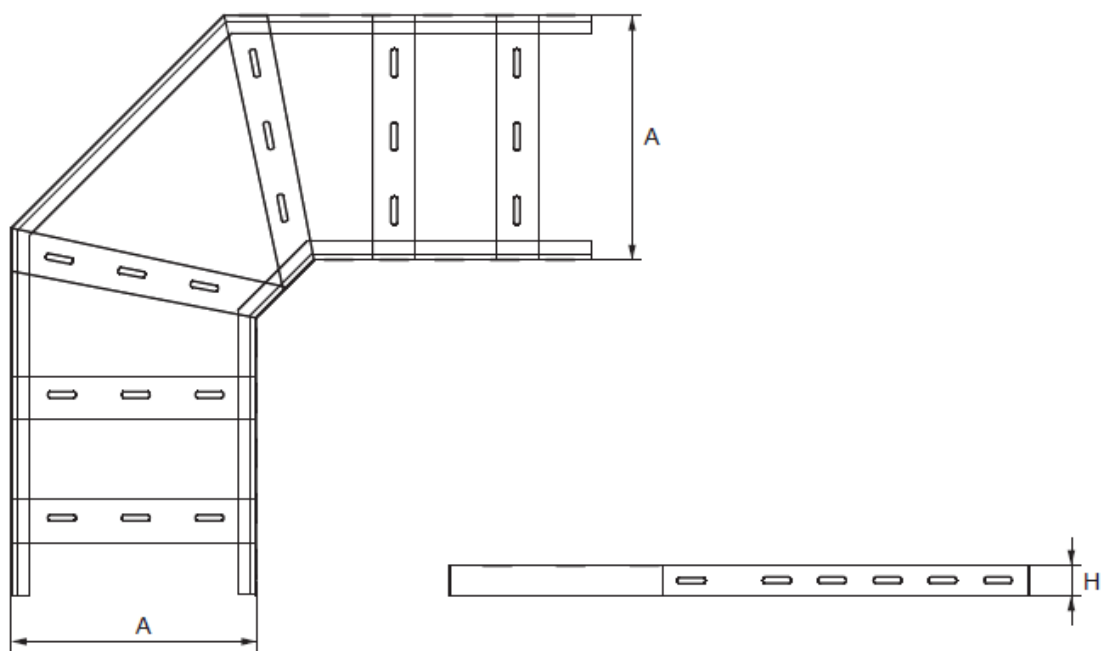
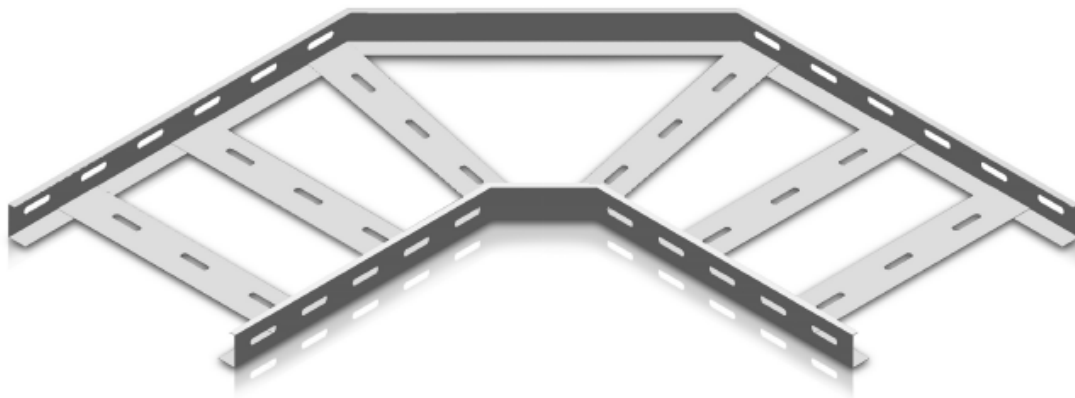



РЕШЕТКАТА „Т“ - СПОЈКА



LATICE „T“ - CLUTCH

	Ознака Order code	Ширина / Width A (mm)	Ширина / Width B (mm)	Висина / Height H (mm)	Дебелина / Thickness δ (mm)
98	RT - 200	200	200	50	$\delta = 2.0$
99	RT - 200	200	300	50	$\delta = 2.0$
100	RT - 200	300	300	50	$\delta = 2.0$
101	RT - 200	300	400	50	$\delta = 2.0$
102	RT - 200	400	400	50	$\delta = 2.0$
103	RT - 200	400	500	50	$\delta = 2.0$
104	RT - 200	500	500	50	$\delta = 2.0$
105	RT - 200	500	600	50	$\delta = 2.0$
106	RT - 200	600	600	50	$\delta = 2.0$

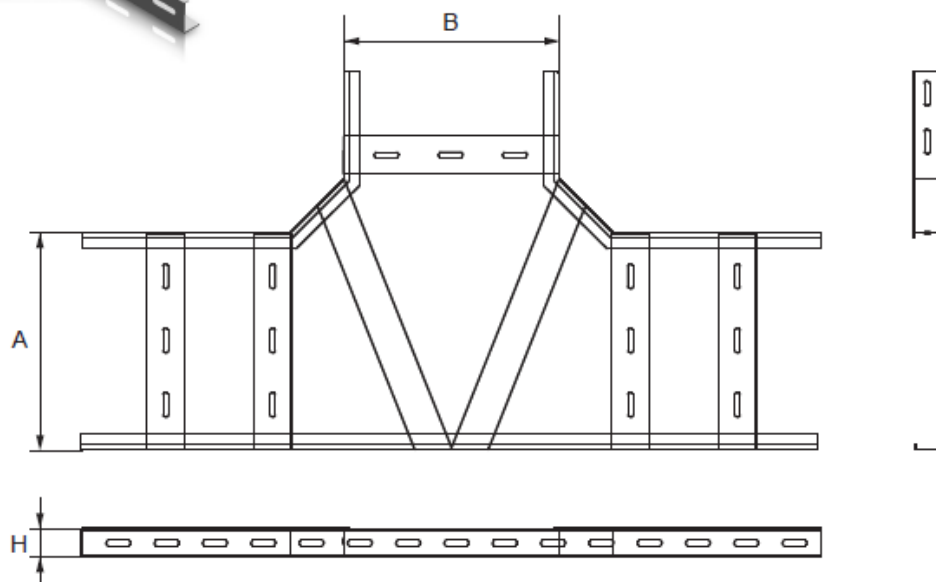
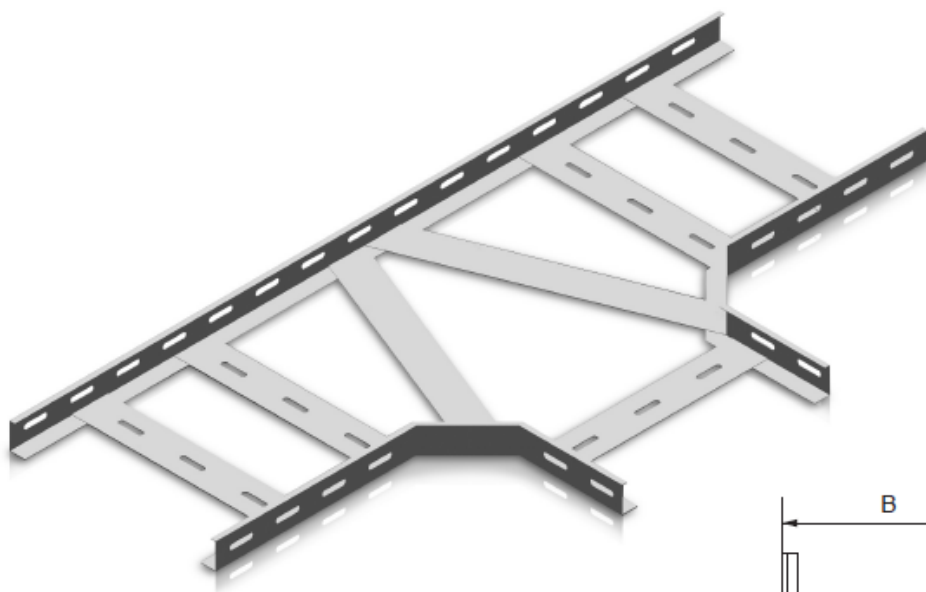



bul.Goce Delcev 50
2 000 Stip
R. Makedonija
e-mail:aktiva@aktiva.mk
www.aktiva.mk

Tel. ++389 32 606 000
++389 32 608 001
++389 32 607 002
++389 32 607 003

